



LAP-BAND AP[®] Adjustable Gastric Banding System with RapidPort[®] EZ and OMNIFORM[®] Design

DIRECTIONS FOR USE (DFU)

A detailed booklet called “The LAP-BAND[®] System, Surgical Aid in the Treatment of Obesity, A decision guide for Adults” is available from Allergan. This booklet should be provided to all patients considering LAP-BAND[®] System surgery. The booklet includes a patient acknowledgment/consent form which should be completed prior to surgery.

Rx Only



TABLE OF CONTENTS

Description	1
Intended Use / Indications	1
Contraindications	1
Warnings.....	1
Precautions.....	1
Adverse Events.....	2
Clinical Experience	4
Individualization of Treatment	7
Patient Counseling Information	8
How Supplied.....	8
Operator's Manual	9
LAP-BAND AP® System Surgical Procedure.....	10
Instructions for Use: Band Adjustment	12
Authorized Training Program and Product Ordering Information.....	13

LAP-BAND AP® Adjustable Gastric Banding System with RapidPort® EZ and Omniform® Design

DESCRIPTION

Cat. No. B-2360

LAP-BAND AP® System Standard w/ RapidPort® EZ

Cat. No. B-2365

LAP-BAND AP® System Large w/ RapidPort® EZ

The LAP-BAND AP® Adjustable Gastric Banding System is designed to induce weight loss in severely obese patients by limiting food consumption. The band's slip-through buckle design makes laparoscopic placement around the stomach easier, allowing the formation of a small gastric pouch and stoma. No cutting or stapling of the stomach is required, and there is no bypassing of portions of the stomach or intestines.

The LAP-BAND AP® Adjustable Gastric Banding System with OMNIFORM® Design is the latest advance in laparoscopic adjustable gastric banding for the treatment of morbid obesity. The initial pouch and stoma sizes are established through the use of the Calibration Tube. The inner surface of the band is inflatable and connected by kink-resistant tubing to the Access Port. This permits post-operative percutaneous, stoma size adjustment. Dietary and behavior modification counseling and frequent, long-term follow-up are required for all patients after weight-loss surgery.

Surgeons planning laparoscopic placement must have extensive advanced laparoscopic experience, i.e., funduplications as well as previous experience in treating obese patients, and have the staff and commitment to comply with the long-term follow-up requirements of obesity procedures. They should comply with the American Society for Metabolic & Bariatric Surgeons (ASMBS) and the Society of American Gastrointestinal Endoscopic Surgeons (SAGES) joint "Guidelines for Surgical Treatment of Morbid Obesity" and the SAGES "Guidelines for Framework for Post-Residency Surgical Education and Training". Surgeon participation in a training program authorized by Allergan or by an authorized Allergan distributor is required prior to use of the LAP-BAND AP® System. Please see the last page for directions on obtaining additional information.

BRIEF DESCRIPTION OF PROCEDURE

During the surgical procedure, the inflatable band and the access port are flushed with sterile saline. The band is placed around the stomach and inflated with sterile saline to create the proper stoma diameter and pouch size using the calibration tube. The tubing is connected to the access port and the Access Port is placed on the rectus muscle or fixed in an accessible subcutaneous space. Arrows pointing in the direction of the Access Port are printed on the tubing. These arrows assist the surgeon in identifying the correct tubing orientation. The tubing may be shortened to tailor the position of the port to the patient. The Access Port may then be sutured in place utilizing the suture holes in the port base or secured by use of the RapidPort® EZ Port Applier (Cat. No. B-20390). Postoperatively, the surgeon may adjust the stoma size percutaneously by injecting or aspirating saline with the Access Port Needle.

Please refer to the Surgical Procedure section for more information.

INTENDED USE / INDICATIONS

The LAP-BAND® System is indicated for weight reduction for patients with obesity, with a Body Mass Index (BMI) of at least 40 kg/m² or a BMI of at least 30 kg/m² with one or more obesity related comorbid conditions.

It is indicated for use in adult patients who have failed more conservative weight reduction alternatives, such as supervised diet, exercise and behavior modification programs. Patients who elect to have this surgery must make the commitment to

accept significant changes in their eating habits for the rest of their lives.

CONTRAINDICATIONS

The LAP-BAND AP® System is contraindicated in:

1. Patients with inflammatory diseases of the gastrointestinal tract, including severe intractable esophagitis, gastric ulceration, duodenal ulceration, or specific inflammation such as Crohn's disease.
2. Patients with severe cardiopulmonary diseases or other serious organic disease which may make them poor surgical candidates.
3. Patients with potential upper gastrointestinal bleeding conditions such as esophageal or gastric varices or congenital or acquired intestinal telangiectases.
4. Patients with portal hypertension.
5. Patients with congenital or acquired anomalies of the GI tract such as atresias or stenoses.
6. Patients who have/experience an intra-operative gastric injury during the implantation procedure, such as a gastric perforation at or near the location of the intended band placement.
7. Patients with cirrhosis.
8. Patients with chronic pancreatitis.
9. Patients who are addicted to alcohol and/or drugs.
10. Non-adult patients (patients under 18 years of age).
11. Patients who have an infection anywhere in their body or where the possibility of contamination prior to or during the surgery exists.
12. Patients on chronic, long-term steroid treatment.
13. Patients who are unable or unwilling to comply with dietary restrictions that are required by this procedure.
14. Patients who are known to have, or suspected to have, an allergic reaction to materials contained in the system or who have exhibited pain intolerance to implanted devices.
15. Patients or family members with a known diagnosis or pre-existing symptoms of autoimmune connective tissue disease such as systemic lupus erythematosus or scleroderma.
16. Pregnancy: Placement of the LAP-BAND AP® System is contraindicated for patients who currently are or may be pregnant. Patients who become pregnant after band placement may require deflation of their bands.

WARNINGS

1. Laparoscopic or laparotomic placement of the LAP-BAND AP® System is major surgery and death can occur.
2. Failure to secure the band properly may result in its subsequent displacement and necessitate a second operation.
3. A large hiatal hernia may prevent accurate positioning of the device. Placement of the band should be considered on a case-by-case basis depending on the severity of the hernia.
4. The band should not be sutured to the stomach. Suturing the band directly to the stomach may result in erosion.
5. Patients' emotional and psychological stability should be evaluated prior to surgery. Gastric banding may

be determined by physician to be inappropriate for select patients.

6. Patients should be advised that the LAP-BAND AP® System is a long-term implant. Explant (removal) and replacement surgery may be indicated at any time. Medical management of adverse reactions may include explanation. Revision surgery for explantation and replacement may also be indicated to achieve patient satisfaction.
7. Esophageal distension or dilatation has been reported to result from stoma obstruction from over-restriction by excessive band inflation. Patients should not expect to lose weight as fast as gastric bypass patients, and band inflation should proceed in small increments. Deflation of the band is recommended if esophageal dilatation develops.
8. Some types of esophageal dysmotility may result in inadequate weight loss or may result in esophageal dilatation when the band is inflated and may require removal of the band. On the basis of each patient's medical history and symptoms, surgeons should determine whether esophageal motility function studies are necessary. If these studies indicate that the patient has esophageal dysmotility, the increased risks associated with band placement must be considered.
9. Patients with Barrett's esophagus may have problems associated with their esophageal pathology that could compromise their post-surgical course. Use of the band in these patients should be considered on the basis of each patient's medical history and severity of symptoms.
10. Patient self-adjustment of superficially placed access ports has been reported. This can result in inappropriate band tightness, infection and other complications.

PRECAUTIONS

1. Laparoscopic band placement is an advanced laparoscopic procedure. Surgeons planning laparoscopic placement must:
 - a. Have extensive advanced laparoscopic experience, i.e., funduplications.
 - b. Have previous experience in treating obese patients and have the staff and commitment to comply with the long-term follow-up requirements of obesity procedures.
 - c. Participate in a training program for the LAP-BAND® System authorized by Allergan or an authorized Allergan distributor (this is a requirement).
 - d. Be observed by qualified personnel during their first band placements.
 - e. Have the equipment and experience necessary to complete the procedure via laparotomy if required.
 - f. Be willing to report the results of their experience to further improve the surgical treatment of severe obesity.
2. It is the responsibility of the surgeon to advise the patient of the known risks and complications associated with the surgical procedure and implant.
3. As with gastroplasty surgeries, particular care must be taken during dissection and during implantation of the device to avoid damage to the gastrointestinal tract. Any damage to the stomach during the procedure may result in erosion of the device into the GI tract.
4. During insertion of the calibration tube, care must be taken to prevent perforation of the esophagus or stomach.

5. Revision procedures may require the existing staple line to be partially disrupted to avoid having a second point of obstruction below the band. As with any revision procedure, the possibility of complications such as erosion and infection is increased. Any damage to the stomach during the procedure may result in peritonitis and death or in late erosion of the device into the GI tract.
6. Care must be taken to place the Access Port in a stable position away from areas that may be affected by significant weight loss, physical activity or subsequent surgery. Failure to do so may result in the inability to perform percutaneous band adjustments.
7. Care must be taken during band adjustment to avoid puncturing the tubing that connects the Access Port and band, as this will cause leakage and deflation of the inflatable section.
8. Failure to create a stable, smooth path for the Access Port tubing, without sharp turns or bends, can result in tubing breaks and leakage. In order to avoid incorrect placement, the port should be placed lateral to the trocar opening. A pocket must be created for the port so that it is placed far enough from the trocar path to avoid abrupt kinking of the tubing. The tubing path should point in the direction of the Access Port connector so that the tubing will form a straight line with a gentle arching transition into the abdomen. (See **Figure 1**).

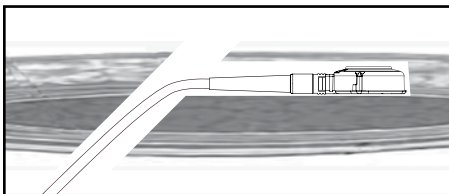

Figure 1. Gentle arching tubing transition through trocar hole

9. The LAP-BAND AP® System is for single use only. Do not use a band, access port applicator tool, Access Port, needle or calibration tube that appears damaged (cut, torn, etc.) in any way. Do not use any of the above components if the package has been opened or damaged or if there is any evidence of tampering. If packaging has been damaged, the product may not be sterile and may cause an infection.
10. Do not attempt to clean or re-sterilize any part of the LAP-BAND AP® System. The product may be damaged or distorted if re-sterilized.
11. Special care must be used when handling the device because contaminants such as lint, fingerprints and talc may lead to a foreign body reaction.
12. Care must be taken to avoid damaging the band, its inflatable section or tubing, the Access Port or the calibration tube. Use only rubber-shod clamps to clamp tubing.
13. The band, Access Port and calibration tube may be damaged by sharp objects and manipulation with instruments. A damaged device must not be implanted. For this reason, a stand-by device should be available at the time of surgery.
14. Failure to use the tubing end plug during placement of the band may result in damage to the band tubing during band placement.
15. Do not push the tip of any instrument against the stomach wall or use excessive electrocautery. Stomach perforation or damage may result in peritonitis and death.

16. Over-dissection of the stomach during placement may result in slippage or erosion of the band and require reoperation.
17. Failure to use an appropriate atraumatic instrument to lock the band may result in damage to the band or injury to surrounding tissues.
18. When adjusting band volume, take care to ensure the radiographic screen is perpendicular to the needle shaft (the needle will appear as a dot on the screen). This will facilitate adjustment of needle position as needed while moving through the tissue to the port.
19. When adjusting band volume, use of an inappropriate needle may cause Access Port leakage and require reoperation to replace the port. Use only LAP-BAND AP® System Access Port Needles. Do not use standard hypodermic needles, as these may cause leaks.
20. When adjusting band volume, the needle must be inserted perpendicular to the Access Port septum. Failure to do so may cause damage to the port and result in leaks.
21. When adjusting band volume never enter the Access Port with a "syringeless" needle. The fluid in the device is under pressure and will be released through the needle.
22. When adjusting band volume after the septum is punctured, do not tilt or rock the needle, as this may cause fluid leakage or damage to the septum.
23. If fluid has been added, it is important to establish that the stoma is not too small before discharge. Care must be taken to not add too much saline, thereby closing the gastric stoma. Check the adjustment by having the patient drink water. If the patient is unable to swallow, remove some fluid from the port, then re-check. A physician familiar with the adjustment procedure must be available for several days post-adjustment to deflate the band in case of an obstruction.
24. It is the responsibility of the surgeon to advise the patient of the dietary restrictions that follow this procedure and to provide diet and behavior modification support. Failure to adhere to the dietary restrictions may result in obstruction and/or failure to lose weight.
25. Patients must be carefully counseled on the need for proper dietary habits. They should be evaluated for nutritional (including caloric) needs and advised on the proper diet selection. The physician may choose to prescribe appropriate dietary supplements. Appropriate physical monitoring and dietary counseling should take place regularly.
26. Patients must be cautioned to chew their food thoroughly. Patients with dentures must be cautioned to be particularly careful to cut their food into small pieces. Failure to follow these precautions may result in vomiting, stomal irritation and edema, possibly even obstruction.
27. Patients must be seen regularly during periods of rapid weight loss for signs of malnutrition, anemia or other related complications.
28. Anti-inflammatory agents, such as aspirin and non-steroidal anti-inflammatory drugs (NSAIDs), may irritate the stomach and should be used with caution. The use of such medications may be associated with an increased risk of erosion.
29. Patients who become pregnant, severely ill, or who require more extensive nutrition may require deflation of their bands.
30. All patients should have their reproductive areas shielded during radiography.

31. Insufficient weight loss may be caused by pouch enlargement or, more infrequently, band erosion in which case further inflation of the band would not be appropriate.
32. Elevated homocysteine levels have been found in patients actively losing weight after obesity surgery. Supplemental folate and vitamin B12 may be necessary to maintain normal homocysteine levels. Elevated homocysteine levels may increase cardiovascular risk and the risk of neural tube abnormalities.
33. Although there have been no reports of autoimmune disease with the use of the LAP-BAND® System, autoimmune diseases/connective tissue disorders (i.e., systemic lupus erythematosus, sclero-derma) have been reported following long-term implantation of other silicone implants. However, there is no conclusive evidence to substantiate a relationship between connective-tissue disorders and silicone implants.

ADVERSE EVENTS

It is important to discuss all possible complications and adverse events with your patient. Complications which may result from the use of this product include the risks associated with the medications and methods utilized in the surgical procedure, the risks associated with any surgical procedure and the patient's degree of intolerance to any foreign object implanted in the body.

Perforation of the stomach can occur. **Death can also occur.** Specific complications of laparoscopic surgery can include spleen damage (sometimes requiring splenectomy) or liver damage, bleeding from major blood vessels, lung problems, thrombosis, and rupture of the wound.

Ulceration, gastritis, gastroesophageal reflux, heartburn, gas bloat, dysphagia, dehydration, constipation, and weight regain have been reported after gastric restriction procedures.

Band slippage and/or pouch dilatation can occur. Gastroesophageal reflux, nausea and/or vomiting with early or minor slippage may be successfully resolved by band deflation in some cases. More serious slippages may require surgery to reposition and/or remove the band. Immediate reoperation to remove the band is indicated if there is total stoma outlet obstruction that does not respond to band deflation or if there is abdominal pain.

Gastric banding done as a revision procedure has a greater risk of complications. Prior abdominal surgery is commonly associated with adhesions involving the stomach. In the US pivotal study of severely obese adults, 42% of the subjects undergoing revision surgery were reported to have adhesions involving the stomach. Care and time must be taken to adequately release the adhesions to provide access, exposure and mobilization of the stomach for a revision procedure.

There is a risk of band erosion into stomach tissue. Erosion of the band into stomach tissue has been associated with revision surgery after the use of gastric-irritating medications, after stomach damage and after extensive dissection or use of electrocautery, and during early experience. Symptoms of band erosion may include reduced weight loss, weight gain, Access Port infection, or abdominal pain. Reoperation to remove the device is required.

Reoperation for band erosions may result in a gastrectomy of the affected area. Eroded bands have been removed gastroscopically in a very few cases. Consultation with other experienced LAP-BAND® System surgeons is strongly advised in these cases.

Esophageal distension or dilatation has been infrequently reported. This is most likely a consequence of incorrect band placement, over-restriction or stoma obstruction. It can also be due to excessive vomiting or patient noncompliance, and may be more likely in cases of pre-existing esophageal dysmotility. Deflation of the band is recommended if esophageal dilatation develops. A revision procedure may be necessary to reposition or remove the band if deflation does not resolve the dilatation.

Obstruction of stomach has been reported as both an early and a late complication of this procedure. This can be caused by edema, food, improper initial calibration, band slippage, pouch torsion, or patient non-compliance regarding choice and chewing of food.

Infection can occur in the immediate post-operative period or years after insertion of the device. In the presence of infection or contamination, removal of the device is indicated.

Unplanned deflation of the band may occur due to leakage from the band, the port or the connecting tubing.

Nausea and vomiting may occur, particularly in the first few days after surgery and when the patient eats more than recommended. Nausea and vomiting may also be symptoms of stoma obstruction or a band/stomach slippage. Frequent, severe vomiting can result in pouch dilatation, stomach slippage or esophageal dilatation. Deflation of the band is immediately indicated in all of these situations. Deflation of the band may alleviate excessively rapid weight loss and nausea and vomiting. Reoperation to reposition or remove the device may be required.

Rapid weight loss may result in symptoms of malnutrition, anemia and related complications (i.e., polyneuropathies). Deflation of the band may alleviate excessively rapid weight loss.

Rapid weight loss may result in development of cholelithiasis which may require cholecystectomy.

The following table summarizes serious adverse events (SAEs) that were reported to have occurred during the 3-year US pivotal clinical trial in severely obese adults, initiated in 1995. A total of 299 subjects were studied with a total of 633 subject years.

Adverse Event	% of 299 subjects
Band Slippage, Pouch Dilatation	11
Stoma Obstruction	8
Gastroesophageal Reflux	3
Esophageal Dilatation	2
Cholelithiasis	2
Incisional Infection	2
Abdominal Pain	2
Gastroenteritis	2
Nausea and/or Vomiting	2
Port Leak	2
Delayed Esophageal Emptying	1
GI Perforation	1
Hernia	1
Band Erosion	1
Chest Pain	1
Dysphagia	1
Infection	1
Asthma	1
Atelectasis	1
Dehydration	1
Headache	1
Abnormal Healing	1
Hiatal Hernia	1
Improper Band Placement	1
Respiratory Disorder	1
Thrombosis	1
Thyroid Disorder	1
Death	0

There were additional occurrences of these events that were considered to be non-serious.

Table 2 shows occurrences of all adverse events reported at a rate of 5% or more.

Adverse Event	# of subjects	% of 299 subjects
Digestive		
Nausea and/or Vomiting	152	51
Gastroesophageal Reflux	103	34
Stoma Obstruction	41	14
Constipation	27	9
Dysphagia	26	9
Diarrhea	22	7
Abnormal Stools	18	6
Body as a Whole		
Abdominal Pain	80	27
Asthenia	25	8
Incisional Infection	21	7
Infection	20	7
Fever	18	6
Hernia	16	5
Pain	16	5
Chest Pain	15	5
Pain Incision	14	5
Band Specific		
Band Slippage/ Pouch Dilatation	72	24
Metabolic and Nutritional		
Healing Abnormal	23	8
Port-Specific		
Port Site Pain	26	9
Port Displacement	18	6
Skin and Appendages		
Alopecia	23	8

Other adverse events considered related to the LAP-BAND® System that occurred in fewer than 1% of subjects included: esophagitis, gastritis, hiatal hernia, pancreatitis, abdominal pain, hernia, incisional infection, infection, redundant skin, dehydration, GI perforation, diarrhea, abnormal stools, constipation, flatulence, dyspepsia, eructation, cardiospasm, hematemesis, asthenia, fever, chest pain, incision pain, contact dermatitis, abnormal healing, edema, paresthesia, dysmenorrhea, hypochromic anemia, band leak, cholecystitis, esophageal dysmotility, esophageal ulcer, esophagitis, port displacement, port site pain, spleen injury, and wound infection.

Twenty-six subjects (9%, 26/299) had a total of 27 reoperations. Thirteen of these 27 (48%) revision procedures were completed laparoscopically. In 9 of the 27 procedures (33%), the band was removed and replaced with a new band

in the same procedure. These were due to: 3 initially incorrect placements, 5 stoma obstructions or band slippage/pouch dilatation, and 1 band system leakage. Two subjects had new band replacements at separate interventions. Sixteen of 27 revision procedures (59%) did not require removal of bands. All of these revisions were performed to correct band slippage/pouch dilatation. Six of these (37.5%) were completed laparoscopically. There were no deaths associated with LAP-BAND® System revisions.

Seventy-five subjects had their entire LAP-BAND® Systems explanted. Fifty-one of the 75 explants (68%, 51/75) were counter measures to adverse events. Band slippage/pouch dilatation and/or stoma obstruction was the most common adverse event associated with these explants (32%, 24/75). Other events associated with these explants were erosion (5%, 4/75), infection (4%, 3/75), GI disorders such as gastroesophageal reflux and/or dysphagia (11%, 8/75), LAP-BAND® System leak (4%, 3/75), one needle damage to shell and 2 access port tubing leaks, esophageal disorders, such as dilatation and delayed emptying (7%, 5/75); gastric perforation (3%, 2/75); one abdominal pain; and one respiratory disorder. Insufficient weight loss was also reported as a contributor to the decision to explant in 24 of the 75 explants (32%, 24/75). Data from a post-approval study showed an estimated explant rate of 6.5% per year over the first five years following implantation.

One-year data are available for 149 obese subjects with BMI ≥30 and <40 who underwent LAP-BAND® System placement surgery in a Lower BMI study, initiated in 2007. This study will continue to follow subjects for an additional 4 years (5 years in total). The following table summarizes the SAEs that were reported to have occurred in the US Lower BMI clinical trial.

TABLE 3: SERIOUS ADVERSE EVENTS CONSIDERED RELATED TO THE LAP-BAND® SYSTEM FOR THE US LOWER BMI STUDY

Adverse Event	# of subjects	% of 149 subjects
Abdominal Pain	2	1.3
Shoulder pain	1	0.7
Dysphagia	1	0.7
Medical Device Complication (Band Erosion)	1	0.7
Gastric Outlet Obstruction	1	0.7
Vomiting	1	0.7

These seven device-related SAEs occurred in three subjects (2%, 3/149). They were hospitalized for 7 days or less and discharged following band removal. There were no deaths in the Lower BMI Study.

There were additional occurrences of these events that were considered to be non-serious. Table 4 shows occurrences of all device-related events reported at a rate of 2% or more.

TABLE 4: DEVICE-RELATED ADVERSE EVENTS THAT OCCURRED IN ≥2% OF SUBJECTS IN THE US LOWER BMI STUDY

Adverse Event	Subjects		Events		Mild	Moderate	Severe
	N	(%) ^a	N	(%) ^b	n (%)	n (%)	n (%)
Vomiting	43	(28.9%)	43	(20.0%)	29 (67.4%)	13 (30.2%)	1 (2.3%)
Dysphagia	33	(22.1%)	33	(15.3%)	20 (60.6%)	12 (36.4%)	1 (3.0%)
Post procedural pain	28	(18.8%)	28	(13.0%)	1 (3.6%)	27 (96.4%)	0 (0.0%)
Gastroesophageal reflux disease	22	(14.8%)	22	(10.2%)	15 (68.2%)	7 (31.8%)	0 (0.0%)
Abdominal pain	8	(5.4%)	8	(3.7%)	2 (25.0%)	6 (75.0%)	0 (0.0%)
Nausea	8	(5.4%)	8	(3.7%)	5 (62.5%)	3 (37.5%)	0 (0.0%)
Dyspepsia	7	(4.7%)	7	(3.3%)	4 (57.1%)	3 (42.9%)	0 (0.0%)
Implant Site Pain	7	(4.7%)	7	(3.3%)	6 (85.7%)	1 (14.3%)	0 (0.0%)
Abdominal pain upper	4	(2.7%)	4	(1.9%)	3 (75.0%)	1 (25.0%)	0 (0.0%)
Constipation	4	(2.7%)	4	(1.9%)	3 (75.0%)	1 (25.0%)	0 (0.0%)
Medical device complication ^c	4	(2.7%)	4	(1.9%)	2 (50.0%)	1 (25.0%)	1 (25.0%)
Dehydration	3	(2.0%)	3	(1.4%)	1 (33.3%)	2 (66.7%)	0 (00%)
Device malfunction ^d	3	(2.0%)	3	(1.4%)	0 (0.0%)	2 (66.7%)	1 (33.3%)
Shoulder pain	3	(2.0%)	3	(1.4%)	1 (33.3%)	2 (66.7%)	0 (0.0%)

^a Percentage is based on 149 subjects

^b Percentage is based on 215 device-related adverse events

^c Complications included band erosion, tubing palpated in umbilical hernia, and band slippage

^d Malfunctions included partial slip, flipped port, and band slippage.

Other adverse events considered related to the LAP-BAND® System that occurred in fewer than 2% of study patients included: diarrhea (n=2), gastric pouch dilatation (n=2), gastritis (n=2), esophageal dilatation (n=2), syncope (n=2), seroma (n=2). Other events reported to occur in only one patient per event included; abdominal discomfort, alopecia, anemia, arthralgia, decrease blood folate, flatulence, gastrointestinal motility disorder, bronchitis, chills, implant site infection, implant site irritation, implant site hemorrhage, night sweats, hypotrichosis, headache, nail infection, pyrexia, skin irritation, esophageal obstruction, esophageal spasm, postoperative infection, urinary tract infection, muscle spasms, depression, back pain, and hypertension.

Seven subjects (4.6%, 7/149) each required one reoperation, and there were no intraoperative complications. Four of these (57.1%, 4/7) were LAP-BAND® System explantations due to dysphagia (in 2 subjects), erosion of the band, or abdominal pain. Two reoperations were access port revisions due to port flip or port site pain; the original ports were retained. One reoperation was for repositioning of the original band to correct for band slippage.

CLINICAL EXPERIENCE

The LAP-BAND® System is indicated for use only in patients who have failed more conservative weight-reduction alternatives, such as supervised diet, exercise and behavior modification programs. Patients who elect to have this surgery must make the commitment to accept significant changes in their eating habits for the rest of their lives.

The effects of the LAP-BAND® System have been studied in severely obese subjects (BMI ≥ 40 or those who are 100 lbs. or more over their estimated ideal weight) as well as in mild to moderately obese subjects (BMI ≥30 and <40) in the US, in the pivotal study and Lower BMI study, respectively.

Clinical Experience in Severely Obese Adults (initiated in 1995)

Purpose of the Trial:

This study evaluated the safety and effectiveness of the device for use in weight reduction for severely obese patients with a Body Mass Index (BMI) of at least 40, or those who are 100 lbs. or more over their estimated ideal weight, as determined using the 1983 Metropolitan Life Insurance Height and Weight Table (using the midpoint for medium frame).

Study Design:

A 3-year, single-arm, multi-center study was initiated in June 1995 with 299 subjects enrolled at 8 centers under the care of 12 surgeons. All procedures were completed utilizing a perigastric dissection technique with pouches of 25 ml or (later in the study) 15 ml, using the 9.75cm (B-2210) and 10.0cm (B-2220) LAP-BAND® Systems. Of the procedures, 259 were completed laparoscopically and 33 via laparotomy, including 13 intraoperative conversions (4.7% conversion rate).

The primary effectiveness measure was the percent Excess Weight Loss (%EWL) at 1, 2, and 3 years following the LAP-BAND® implantation. The secondary effectiveness measures used in the study determined the differences between the weight loss (at years 1, 2 and 3) and the weight loss/gain experienced by the subject in the years(s) prior to the placement of the LAP-BAND® System. In addition, changes in a subject's quality of life were also determined as part of the secondary effectiveness measure.

The %EWL is defined as weight loss (operative weight minus selected weight) divided by excess weight (operative weight minus ideal weight) multiplied by 100. Study subjects were weighed immediately before surgery, at 3 weeks postoperatively, and then again at regular intervals over the next 3 years (3, 6, 9, 12, 18, 24, 30, and 36 months). The 1983 Metropolitan Life Height and Weight Table was used to determine ideal weight.

The primary safety parameters included incidence and severity of complications. Safety measurements were based on subjects' reported adverse events before surgery (< 3 weeks)

and postoperatively (> 3 weeks), either during scheduled visits or as called to the attention of the study nurse or investigator to report urgent problems. Any noted complications were divided into device-related and non-device-related events.

Subjects Studied:

A total of 299 subjects participated in the U.S. study, with 85% of participants being female and 15% being male. Distribution by race was 81% Caucasian, 15% African-American and 4% Hispanic. The average age at which subjects became obese was 18.4 and the average age at the time of surgery was 38.8 years.

The mean weight at entry into the trial was 293 pounds, with mean excess weight of 156 pounds and mean BMI of 47.4. Thirty percent (30%) of subjects had BMI ≥ 50 and were classified as “superobese.” During the five years prior to surgery, subjects on average gained 54 pounds, with the average BMI increasing from 39 to 47.4. These subjects had significant comorbidities which included: hypertension (42%), gallstone/gallbladder disease (25%), gastrointestinal diseases (24%), asthma (16%), non-insulin dependent diabetes (11%), and insulin dependent diabetes (5%).

Subject Inclusion Criteria:

- Age 18 to 55.
- BMI ≥ 40, or at least 100 pounds above estimated ideal weight.
- Willingness to comply with the substantial lifelong dietary restrictions required by the procedure.
- History of obesity for at least 5 years.
- History of failure with non-surgical, weight loss methods.
- Willingness to follow protocol requirements, including signed informed consent, routine follow-up schedule, completing quality-of-life questionnaires, completing laboratory tests, completing diet and behavior modification counseling.
- Reside within a reasonable distance from the investigator’s office and be able to travel to the investigator to complete all routine follow-up visits.

Subject Exclusion Criteria:

- Surgery or treatment representing an unreasonable risk to the subject.
- Family or subject history of inflammatory disease of the gastrointestinal tract, including gastric ulceration, duodenal ulceration, Grade 2–4 esophagitis, or specific inflammation such as Crohn’s disease or ulcerative colitis.
- Severe cardiopulmonary disease or other serious organic diseases.
- Severe coagulopathy, upper gastrointestinal bleeding conditions such as esophageal or gastric varices, congenital or acquired intestinal telangiectasia.
- Congenital or acquired anomalies of the GI tract such as atresias or stenoses.
- Severe hiatal hernia.
- Pregnancy or the intention of becoming pregnant in the next 12 months.
- Alcohol or drug addiction.
- Mentally retarded, emotionally unstable, or exhibited psychological characteristics.
- Previous bariatric surgery (except Adjustable Silicone Gastric Band), intestinal obstruction or adhesive peritonitis.
- Infection anywhere in the body at the time of surgery.

- Family or subject history of a known diagnosis or pre-existing symptoms of systemic lupus erythematosus, scleroderma, or other autoimmune disease.
- Participating in another ongoing clinical trial in which concomitant diagnostic or therapeutic intervention would adversely affect the integrity of the LAP-BAND® System US Clinical Trial.

Effectiveness Results:

Study subjects achieved significant improvement in %EWL, weight loss, excess weight and BMI at 12, 24 and 36 months following placement of the LAP-BAND® System. Although most improvement was seen in the first 12 months, statistically significant improvement continued through month 36. The effectiveness of the LAP-BAND® System at month 36 (after surgery, endpoint data) is summarized in Table 5.

TABLE 5: SUMMARY OF WEIGHT LOSS RESULTS AT 36 MONTHS		
	Baseline Mean (N=292 at surgery)	36-Month Mean (N=178)
%EWL	N/A	36.20%
Weight (lbs)	293	240.6
Range	193-475	113-406
Mean Excess Wt (Lbs)	156	104
Range	74-335	-15-263
Mean BMI (kg/m ²)	47.4	38.7
Range	35.9-74.3	19.3-63.6

N = Number of Subjects

Primary Effectiveness Results

Percent Excess Weight Loss (%EWL): In the study, the mean EWL increased steadily from 9.9% at 3 weeks to 37.8% at 24 months following the placement of the LAP-BAND® System. Improvements in %EWL through 36 months were significant (p<0.0001) when compared to baseline. This level of improvement has been demonstrated in the medical literature to improve comorbidities.¹

TABLE 6: MEAN %EWL BY VISIT		
VISIT	N	%EWL
6 months	233	26.5
12 months	233	34.5
18 months	190	36.4
24 months	189	37.8
30 months	148	37.9
36 months	178	36.2

N = Number of Subjects

Secondary Effectiveness Results

Weight and Excess Weight Loss: The study showed that the subjects’ mean weight decreased steadily from 293 pounds at baseline to 235 pounds at 30 months post-surgery. Weight loss through 36 months was significant when compared to baseline. The study also showed that mean excess weight was reduced from 156 pounds to 98.2 pounds. The weight changes from baseline were statistically significant at each visit (paired t-test p<0.0001).

The observed level of weight loss at 12 months and beyond is equivalent to almost 20% total weight loss. This 20% total weight loss is substantially greater than the 10% weight loss that has been shown in the literature to improve or resolve comorbid conditions associated with obesity.¹

TABLE 7: MEAN WEIGHT BY VISIT		
VISIT	N	WEIGHT (lbs)
Baseline	288	293.5
6 months	233	254.5
12 months	233	241.8
18 months	190	240.5
24 months	189	234.5
30 months	148	235.4
36 months	178	240.6

N = Number of Subjects

Body Mass Index (BMI) Decrease: The study showed that mean BMI decreased steadily from 47.5 at baseline to 38.1 at 24 months post-surgery. The improvements in BMI from baseline were statistically significant at each visit (paired t-test p<0.0001).

At baseline, 9% of subjects were not morbidly obese (they had a BMI < 40). By 12 months following the placement of the LAP-BAND® System, 60% of subjects were no longer morbidly obese, and one-third were no longer severely obese (they had a BMI < 35). At the start of the study, almost 30% of subjects were super obese (they had a BMI > 50); by 12 months post-surgery only 7% of the subjects were still super obese.

TABLE 8: MEAN BMI BY VISIT		
VISIT	N	BMI
Baseline	288	47.5
6 months	233	41.2
12 months	233	39.0
18 months	190	38.7
24 months	189	38.1
30 months	148	38.1
36 months	178	38.7

N = Number of Subjects

Quality of Life Improvement: Quality of life was evaluated using several validated assessments, including the Beck Depression Index, the MBSR Appearance Evaluation, the RAND SF-36 Mental Health Composite and the RAND SF-36 Physical Health Composite. There were significant (p<0.0001) improvements in the subjects’ physical functioning, social functioning, emotional well-being, and physical and mental health at 12 months and at 36 months following LAP-BAND® System placement, demonstrating a significant improvement in the subjects’ quality of life.

¹ National Institute of Health. “Summary of recommendations,” Clinical guidelines on identification, evaluation, and treatment of overweight and obesity in adults. The evidence report. 1998.

Safety:

Safety endpoints are provided in the Adverse Events section.

Site-to-site variations:

Site-to-site variations were observed in both effectiveness and safety in the US pivotal clinical study. Experience with advanced laparoscopic procedures, attitudes regarding bariatric procedures, and patient management and support practices were factors found to be related to the variations. No center performed more than two to three procedures, on average, a month. This limited and infrequent experience with both laparoscopic placement and patient management was expected to affect, and did affect, the learning curve in each center.

Clinical Experience in Lower BMI Adults (initiated in 2007)

Purpose of the Trial:

This study evaluated the safety and effectiveness of the device for use in weight reduction for obese patients with a lower Body Mass Index, BMI ≥ 30 kg/m² and < 35 kg/m² with or without comorbid conditions or with a BMI ≥ 35 kg/m² and < 40 kg/m² without any severe comorbid conditions.

Study Design:

A single-arm, multi-center study was initiated in November 2007, and 160 subjects enrolled at 7 sites. Subjects completed one-year follow-up in July 2009. Of those enrolled, 149 received LAP-BAND® implantation following screening. Some subjects were placed on pre-surgical liquid diets as advised by study investigators.

The primary effectiveness measure was percent of subjects who achieved clinically successful weight loss at one year following LAP-BAND® implantation, where success was defined as $\geq 30\%$ Excess Weight Loss (EWL). Secondary effectiveness measures included changes from baseline to 12 months in: percent total weight loss (%WL); comorbid conditions of type 2 diabetes, dyslipidemia, and hypertension; and health-related quality of life as measured by the Impact of Weight on Quality of Life-Lite (IWQOL-Lite) questionnaire.

The %EWL is defined as weight loss (baseline weight minus follow-up weight) divided by excess weight (baseline weight minus ideal weight) multiplied by 100. The %WL is defined as weight loss divided by baseline weight. Ideal weight was determined based on a BMI of 25 kg/m². Study subjects were weighed prior to surgery (screening visit and 7 days before surgery), at surgery, at 1 week postoperatively, and at regular intervals over the next year (1, 2, 4, 6, 8, 10, 12 months). Baseline weight is the weight at screening for subjects placed on the pre-surgical diet and at surgery for subjects who were not placed on the diet. Post-surgical follow-up consists of 18 scheduled visits (Week 1 and Months 1, 2, 4, 6, 8, 10, 12, 15, 18, 21, 24, 30, 36, 42, 48, 54, and 60) plus additional unscheduled visits as needed.

The primary safety parameters included incidence and severity of adverse events related to treatment.

Subjects Studied:

A total of 160 subjects were enrolled in the US Lower BMI study. Following screening, 149 subjects received LAP-BAND® implantation, of which 91% were female and 9% were male. Distribution by race was 77% Caucasian, 9% African-American, 11% Hispanic, 1.3% Asian, and 1.3% other. The average age at the time of surgery was 39.3 years. All 149 procedures were completed utilizing a pars flaccida technique, using the LAP-BAND AP® (Standard and Large) Systems, and were completed laparoscopically.

The mean weight at baseline was 215 pounds, with mean excess weight of 63 pounds and mean BMI of 35.4. Fifty-seven percent (57%) of subjects had BMI ≥ 35 and < 40 , and the remainder had BMI < 35 . These subjects had significant obesity related comorbidities which included: osteoarthritis (38%), back pain (35%), gastroesophageal reflux (28%),

depression (28%), respiratory abnormality (26%), dyslipidemia (20%), hypertension (18%), urinary incontinence (11%), venous stasis (7%), sleep apnea (7%), and type 2 diabetes (4%).

Key inclusion criteria:

- Age 18 to 55.
- BMI ≥ 30 kg/m² and < 35 kg/m² with or without obesity-related comorbid conditions or BMI ≥ 35 kg/m² and < 40 kg/m² without any severe comorbid conditions.
- History of obesity for at least 2 years.
- History of failure with non-surgical and more conservative weight-reduction alternatives.
- Physically and mentally able to comply with the visit schedule and behavior modification required for the LAP-BAND®.
- Successful completion of pre-operative screening, educational programs and psychological assessment supporting that the subject is an appropriate bariatric surgical candidate.

Key exclusion criteria:

- History of congenital or acquired anomalies of the gastrointestinal (GI) tract, such as intestinal telangiectasia, intestinal malrotation, duodenal ulceration, previously diagnosed Grade 3-4 esophagitis, congenital abdominal wall defects, or inflammatory bowel disease (i.e. Crohn's disease).
- Severe cardiopulmonary or other serious or uncontrolled organic disease (e.g. thyroid disease).
- Severe coagulopathy, hepatic insufficiency or cirrhosis.
- History of bariatric, gastric, or esophageal surgery.
- History of intestinal obstruction or adhesive peritonitis.
- History of esophageal dysmotility disorders.
- Type I diabetes.
- Pregnancy or intention of becoming pregnant during the study (if female of childbearing potential).
- Uncontrolled psychiatric disorders (including untreated major depression, schizophrenia, substance abuse, bulimia nervosa), immaturity, or lack of family support which would potentially compromise the subject's ability to fully comprehend and/or cooperate with the study protocol.

- Chronic use of aspirin and/or non-steroidal anti-inflammatory medications and unwillingness to discontinue the use of these concomitant medications.
- Concurrent use of weight loss medications.
- Any condition that would be a contraindication in the LAP-BAND® System Directions for Use.

Effectiveness Results:

Study subjects achieved significant improvement in %EWL, excess weight, weight loss, %WL, BMI, waist circumference and hip circumference at 12 months after placement of the LAP-BAND® System. The effectiveness of the LAP-BAND® System at month 12 (after surgery) is summarized in Table 9 (shown below).

Figure 2 shows the average %EWL over time in the first year.

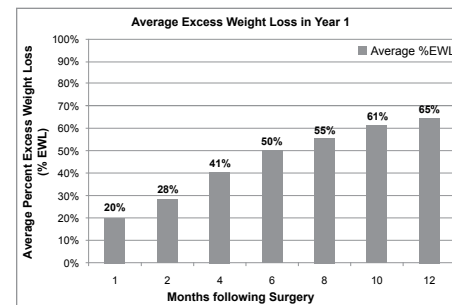

Figure 2: Mean Percent Excess Weight Loss (%EWL) over 12 Months

At baseline, over half (57.0%, 85/149) of subjects had BMI ≥ 35 . By 12 months, only two subjects (1.4%, 2/143) had BMI ≥ 35 . Over half of subjects (65.7%, 94/143) were no longer obese at 12 months. Furthermore, 13.3% (19/143) of subjects were at normal weight (BMI < 25) at 12 months.

Primary Effectiveness Results

Percent of subjects with $\geq 30\%$ EWL at one year following LAP-BAND® System surgery: At one year following LAP-BAND® surgery, 83.9% of subjects ($p < 0.0001$) achieved EWL of at least 30%. The percentages of subjects achieving different levels of %EWL are shown in Tables 10 and 11.

TABLE 9: SUMMARY OF WEIGHT, BMI, AND BODY CHANGES AT 12 MONTHS

Parameter	Baseline Mean (SD) n ^a = 149	Month 12 Mean (SD) n = 143 ^b	Mean Change from Baseline at Month 12	95% CI (Lower, Upper)	P-value ^{c,d}
Weight	214.9 (24.3)	174.7 (24.5)	-39.7	-36.4, -43.0	<0.0001
% WL	N/A	18.3 (8.5)	18.3	16.9, 19.7	<0.0001
Excess Weight (lbs)	62.8 (16.1)	22.8 (19.4)	-39.7	-36.4, -43.0	<0.0001
% EWL	N/A	64.5 (30.3)	64.5	59.5, 69.5	<0.0001
BMI (kg/m ²)	35.4 (2.6)	28.8 (3.2)	-6.5	-6.0, -7.1	<0.0001
% BMI Loss	N/A	18.3 (8.5)	18.3	16.69, 19.7	<0.0001
Waist Circumference (inches)	41.5 (3.5)	35.4 (4.4)	-5.9	-5.4, -6.5	<0.0001
Hip Circumference (inches)	47.7 (3.0)	41.9 (3.5)	-5.8	-5.2, -6.4	<0.0001

^a n is the actual number of patients at visit

^b n=140 for waist circumference and hip circumference

^c P-value is for the evaluation of mean change from baseline by paired t-test or Wilcoxon signed-rank test based on P-value of normality test <0.05

^d P-values test hypotheses pre-specified in the study protocol, but have not been adjusted for multiplicity.

TABLE 10: PERCENT OF SUBJECTS ACHIEVING AT LEAST 30% EWL BY VISIT

Follow-up Visit	N	% of Subjects with ≥30% EWL (without imputation) ^a	% of Subjects with ≥30% EWL (with imputation) ^b
Month 1	149	16.1%	16.1%
Month 2	148	41.2%	40.9%
Month 4	146	70.5%	69.1%
Month 6	149	83.2%	83.2%
Month 8	147	86.4%	85.2%
Month 10	142	85.9%	81.9%
Month 12	143	83.9%	80.5%

N = Number of Subjects at follow-up visit

^a Percentage based on observed cases

^b Percentage with unobserved cases imputed as %EWL < 30% (N=149)

TABLE 11: DISTRIBUTION OF SUBJECTS BY %EWL AT 12 MONTHS

% EWL	N	% of Subjects*
≥10%	141	98.6%
≥30%	120	83.9%
≥50%	98	68.5%
≥70%	62	43.4%
≥90%	29	20.3%

N = 143 subjects at 12 months

* Rows are cumulative frequencies

Secondary Effectiveness Results

Percent Total Weight Loss (%WL): The study showed that mean weight decreased steadily from 214.9 pounds at baseline to 174.7 pounds, resulting in an average 18.3%WL at 12 months. Percent total weight loss through 12 months was significant when compared to baseline (p<0.0001). The percentage of subjects achieving various levels of %WL is shown in Table 12.

TABLE 12: DISTRIBUTION OF SUBJECTS BY %WL AT 12 MONTHS

% WL	N	% of Subjects*
≥5%	135	94.4%
≥10%	115	80.4%
≥15%	94	65.7%
≥20%	64	44.8%
≥25%	29	20.3%

N = 143 subjects at 12 months

* Rows are cumulative frequencies

Change in Comorbid Conditions (Type 2 Diabetes, Dyslipidemia, and Hypertension): In the study, changes in obesity related comorbid conditions were based on Investigator assessments of the severity of the conditions at each timepoint. At 12 months post-surgery, improvement was noted in type 2 diabetes, dyslipidemia, and hypertension. The number of subjects with each comorbid condition is small;

therefore, it is difficult to make definitive statements regarding improvement in the conditions. Table 13 shows the change in these three comorbidities at 12 months following LAP-BAND® placement. These reported changes in comorbid conditions were consistent with changes in associated laboratory values, as shown in Tables 14-16.

Site-to-site variations:

All sites in the study had the majority (76%-100%) of subjects achieving ≥30%EWL.

TABLE 13: CHANGE IN COMORBID CONDITIONS AT 12 MONTHS

Comorbid Condition	Surgery Status N (%) *	Resolved n (%) **	Improved n (%) **	No Change n (%) **	Worsened n (%) **
Diabetes Type II	6 (4.0%)	2 (33.3%)	0 (0.0%)	4 (66.7%)	0 (0.0%)
Dyslipidemia	29 (19.5%)	8 (27.6%)	0 (0.0%)	21 (72.4%)	0 (0.0%)
Hypertension	27 (18.1%)	6 (22.2%)	2 (7.4%)	19 (70.4%)	0 (0.0%)

N is number of subjects having comorbid condition at surgery.

*% is of total population (149).

**% is of N for each comorbid condition.

TABLE 14: CHANGES IN FASTING PLASMA GLUCOSE AND GLYCOSYLATED HEMOGLOBIN (HBA1C)

Lab Test	Subject Group	n ^a	Screening		Month 12 Change from Screening (Month 12-Screening)	
			Mean	SD	Mean	95% CI
Fasting Plasma Glucose (mg/dl)	All Subjects	145	93.4	14.1	-3.6	-5.6, -1.6
	Subjects with Abnormal baseline values ^b	5	149.2	15.4	-40.4	-74.1, -6.7
HbA1c (%)	All Subjects	145	5.4	0.5	-0.1	-0.1, -0.03
	Subjects with Abnormal baseline values ^c	2	7.5	0.5	-0.8	-13.5, 11.9

^a n is the number of patients with values at Screening and Month 12

^b Abnormal Fasting Plasma Glucose is defined as ≥ 126 mg/dL

^c Abnormal HbA1c is defined as ≥ 7%

IWQOL-Lite: Quality of life significantly improved as measured by the Impact of Weightton Quality of Life-Lite assessment. The mean IWQOL-Lite score was 62.8 at baseline, and improved to 90.6 at 12 months (p<0.0001). Significant improvements were observed in all five scale domains (p<0.0001), as shown in Table 17.

Additional Effectiveness Results

Changes in Other Obesity Related Comorbid Conditions: In addition to the comorbidities of dyslipidemia, Type 2 diabetes, and hypertension, additional comorbidities were assessed by the Investigator for severity at baseline and Month 12. All comorbid conditions demonstrated improvement or resolution at Month 12 with the LAP-BAND® System, as shown in Table 18.

Other Patient Reported Outcomes: Consistent with improvements seen in IWQOL-Lite, significant improvements from baseline were seen at Month 12 in other patient reported outcomes including the SF-36, Beck Depression Inventory-II, Three Factor Eating Questionnaire, and Questionnaire on Eating and Weight Patterns – Revised.

Safety:

Safety endpoints are provided in the Adverse Events section.

INDIVIDUALIZATION OF TREATMENT

Placement of the LAP-BAND® System is contraindicated for patients who currently are or may be pregnant. Patients who become pregnant or severely ill after implantation of the LAP-BAND® System, or who require more extensive nutrition, may require deflation of their bands. In rare cases, removal may be needed.

International data suggests that hyper-insulinemia, insulin resistance and disease(s) associated with insulin resistance, poor physical activity, pain and poor general health responses to the SF-36 Health Survey are associated with a slower weight loss.

Older, less physically able and insulin resistant patients are likely to lose weight at a slower rate than younger physically able persons.

Patients who are super-obese can achieve weight reduction sufficient to improve health and quality of life with the LAP-BAND® System but may remain severely obese. They may lose more weight with a malabsorptive procedure or a procedure with a malabsorptive component. The patient's weight loss needs and expectations should be considered when selecting an obesity procedure.

TABLE 15: CHANGES IN LIPIDS [TOTAL CHOLESTEROL, HIGH DENSITY LIPOPROTEINS (HDL), LOW DENSITY LIPOPROTEINS (LDL), AND TRIGLYCERIDES]

Lab Test	Subject Group	n ^a	Screening		Month 12 Change from Screening (Month 12-Screening)	
			Mean	SD	Mean	95% CI
Cholesterol (mg/dl)	All Subjects	143	204.5	38.1	-13.7	-18.6, -8.9
	Subjects with Abnormal baseline values ^b	24	258.9	20.7	-39.4	-52.8, -26.0
HDL (mg/dl)	All Subjects	143	55.7	13.7	5.8	4.0, 7.6
	Subjects with Abnormal baseline values ^c	15	36.7	2.5	7.7	4.2, 11.3
LDL (mg/dl)	All Subjects	143	121.3	30.4	-13.4	-17.6, -9.1
	Subjects with Abnormal baseline values ^d	16	171.3	14.8	-46.8	-58.3, -35.3
Triglycerides (mg/dL)	All Subjects	143	137.2	67.5	-30.7	-40.0, -21.3
	Subjects with Abnormal baseline values ^e	22	261.4	61.5	-98.7	-135.9, -61.5

^a n is the number of patients with values at Screening and Month 12
^b Abnormal Cholesterol is defined as ≥ 240 mg/dL
^c Abnormal HDL is defined as < 40 mg/dL

^d Abnormal LDL is defined as ≥ 160 mg/dL
^e Abnormal Triglycerides are defined as ≥ 200 mg/dL

TABLE 16: CHANGES IN BLOOD PRESSURE [SYSTOLIC BLOOD PRESSURE (SBP) AND DIASTOLIC BLOOD PRESSURE (DBP)]

Lab Test	Subject Group	n ^a	Screening		Month 12 Change from Screening (Month 12-Screening)	
			Mean	SD	Mean	95% CI
SBP (mm Hg)	All Subjects	142	127.6	14.8	-8.1	-10.9, -5.3
	Subjects with Abnormal baseline values ^b	27	150.9	10.0	-21.0	-28.2, -13.9
DBP (mm Hg)	All Subjects	142	79.1	9.3	-3.1	-4.8, -1.3
	Subjects with Abnormal baseline values ^c	16	94.3	4.9	-9.4	-15.2, -3.7

^a n is the number of patients with values at Screening and Month 12
^b Abnormal SBP is defined as ≥ 140 mm Hg

^c Abnormal DBP is defined as ≥ 90 mm Hg

PATIENT COUNSELING INFORMATION

A detailed booklet called "The LAP-BAND® System, Surgical Aid in the Treatment of Obesity, A decision guide for Adults" is available from Allergan. This booklet should be provided to all patients considering LAP-BAND® System surgery. This booklet includes a patient acknowledgment/consent form which should be completed prior to surgery.

HOW SUPPLIED

All components of the LAP-BAND AP® Adjustable Gastric Banding System are for single use only.

The device is provided sterile in double packaging with a protective outer container. The Access Port needle is provided sterile in separate packaging.

CAUTION: If the package has been damaged or if the inner package is opened outside the sterile field, the product must be considered non-sterile and may cause infection of the patient.

TABLE 17: CHANGE IN IWQOL-LITE SCORE AT 12 MONTHS

Domains	N	Baseline Mean	Month 12 Mean	Mean Change	P-value ^a
Physical Function	142	60.9	92.7	31.8	<0.0001
Self-Esteem	141	43.6	80.4	36.8	<0.0001
Sexual Life	139	66.3	89.0	22.7	<0.0001
Public Distress	143	79.0	96.6	17.6	<0.0001
Work	143	75.8	95.7	19.9	<0.0001
Total Score	142	62.5	90.5	28.0	<0.0001

N = Number of Subjects with scores at both baseline and 12 months
^a P-values test hypotheses pre-specified in the study protocol, but have not been adjusted for multiplicity.

The calibration tube is provided clean and non-sterile and does not require sterilization.

LAP-BAND® System boxes should be stored in a clean, dry location (standard hospital supply storage).

The LAP-BAND® System has a two-year shelf life.

REQUIRED EQUIPMENT AND MATERIALS (INCLUDED)

System Components:

- LAP-BAND AP® Adjustable Gastric Banding System (sterile), one each
- RapidPort® EZ Access Port (sterile), one each
- Access Port Needle, 89 mm (3.5 inch), (sterile), one each
- Band blunt flushing needle, 16 gauge, 40.5 mm (1.6 inch) (sterile), one each
- Access Port blunt flushing needle, 22 gauge, 57 mm (2.25 inch) (sterile), one each
- Strain Relief (sterile), one each
- End Plug (sterile), one each

The LAP-BAND AP® System is available in two sizes, Standard and Large. The physician should choose the appropriate size depending upon the patient's individual anatomy. Most patients with correctly fitted bands report minimal, if any, restriction following resolution of post-operative edema until saline is added to the band, regardless of band size. The Large band is normally used for reoperations (particularly conversion from other procedures) and the pars flaccida dissection. Surgeons are advised to evaluate the amount of tissue within the band prior to band locking and suturing in place, and, if it appears excessive, to remove some omental tissue or move the dissection closer to the stomach wall or higher on the stomach. Additional information regarding size selection is provided in the training program.

LAP-BAND AP® Adjust Gastric Banding System Features:

The LAP-BAND AP® System is made of silicone elastomer that forms a ring around the proximal stomach when fastened. The band transitions to a radiopaque 50 cm-long silicone tube. Its kink-resistance and arrows printed on top aid the surgeon in placing it toward the Access Port. An end plug seals the system while the band is passed around the stomach.

Access Port:

The RapidPort® EZ Access Port is for percutaneous adjustment of the stoma diameter and is self-sealing when penetrated by the Access Port Needle.

TABLE 18: MONTH 12 CHANGE IN STATUS OF OTHER COMORBID CONDITIONS

Comorbid Condition	Present at Baseline n (%) ^a	Resolved ^b	Improved ^c	Unchanged	Worsened ^d
		n (%) ^a	n (%) ^a	n (%) ^a	n (%) ^a
Back Pain	52 (34.9%)	18 (34.6%)	2 (3.8%)	31 (59.6%)	1 (1.9%)
Depression	41 (27.5%)	9 (22.0%)	1 (2.4%)	30 (73.2%)	0 (0.0%)
Gastroesophageal Reflux	42 (28.2%)	30 (71.4%)	0 (0.0%)	9 (21.4%)	0 (0.0%)
Metabolic Syndrome	1 (0.7%)	1 (100.0%)	0 (0.0%)	0 (0.0%)	0 (0.0%)
Osteoarthritis	57 (38.3%)	18 (31.6%)	0 (0.0%)	38 (66.7%)	1 (1.8%)
Respiratory Abnormality	38 (25.5%)	18 (47.4%)	1 (2.6%)	19 (50.0%)	0 (0.0%)
Sleep Apnea	11 (7.4%)	4 (36.4%)	1 (9.1%)	6 (54.5%)	0 (0.0%)
Urinary Incontinence	16 (10.7%)	8 (50.0%)	0 (0.0%)	8 (50.0%)	0 (0.0%)
Venous Stasis	11 (7.4%)	6 (54.5%)	0 (0.0%)	5 (45.5%)	0 (0.0%)

^a n is the number of patients having comorbid conditions at Surgery; percent is of total population;

^b Resolved is defined as patients moving to the None category

^c Improved is defined as patients improving by at least one category but not Resolved

^d Worsened is defined as patients worsening by at least one category

^e n is the number of patients with status Resolved/Improved/Unchanged/Worsened at Month 12; percent is of patients who had condition at Surgery; sum of change in status (Resolved + Improved + Unchanged + Worsened) may not equal Baseline status due to missing data at Month 12.

Features Include:

1. High-compression septum; tested to over 200 punctures with a 20 gauge non-coring needle.
2. Titanium Alloy reservoir with positive tactile feedback designed for long-term durability; resists gouging and retains integrity throughout repeated needle contact.
3. Stainless Steel anchors; method of Access Port fixation, taking the place of suturing.

Warning: the Access Port's Stainless Steel anchors contain Nickel which is a known allergen.

4. Radiopaque and compatible with diagnostic imaging; including MRI and CT scanning, although a minimal "halo" effect has been reported due to the stainless steel tubing connector.
5. Contoured housing; light-weight smooth and rounded.

Access Port Needle Features:

The Access Port needle is a non-coring, deflected-tip ("Huber tip") needle designed to penetrate the Access Port during post-operative adjustment of the LAP-BAND AP® System (see Instructions for Use).

REQUIRED EQUIPMENT AND MATERIALS (NOT INCLUDED):

- Atraumatic graspers
- Sterile Saline (non-pyrogenic, isotonic, 0.9% NaCL)
- Syringe, 5 cc or 10 cc
- Suture or RapidPort® EZ Port Applier Tool (Cat. No. B-20390)
- Rubber-shod clamps (mosquito with tubing sleeves)
- Calibration Tube (non-sterile), part number B-2017

CALIBRATION TUBE:

The calibration tube is provided clean and non-sterile and does not require sterilization. The calibration tube is a dual-lumen translucent silicone tube, 157 cm long with a 13 mm diameter sensor tip at its distal end. A 15 cc to 25 cc balloon for controlled sizing and positioning of the gastric pouch is located 3.5 cm from the distal end of the catheter. The balloon is inflated via an inflation port that remains external during the procedure. The calibration tube is for single use only.

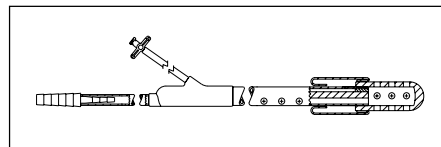

Figure 3. Calibration Tube

Features Include:

1. Integral inflatable gastric pouch sizer balloon
2. Inflation tubing and stopcock attached for ease in filling the calibration balloon
3. Drainage, suction and irrigation

ADDITIONAL EQUIPMENT RECOMMENDED FOR LAPAROSCOPIC PLACEMENT:

- Articulating dissector (long shaft) or Reticulating grasper (long shaft)
- 15 mm or 18 mm trocar
- 5.5 mm reducer for 15 or 18 mm trocar
- 0° and 30° laparoscopes
- Trocars; extra-long trocars sometimes needed
- Extra-long cautery hook and suction irrigation

- A set of long laparoscopic atraumatic graspers, dissectors, scissors, clip applicators, Babcock grasper and fan-type liver retractor

ADDITIONAL EQUIPMENT RECOMMENDED FOR PLACEMENT VIA LAPAROTOMY:

Surgeons electing laparoscopic placement should also be prepared with the equipment necessary for placement via laparotomy.

- Penrose drain
- Abdominal Retractor System for Obesity
- Liver Retractor for Obesity
- Standard set of abdominal surgical retractor instruments as required for laparotomy in the open placement of the LAP-BAND AP® System

SPECIAL EQUIPMENT AND MATERIALS REQUIRED FOR BAND ADJUSTMENT:

- X-ray equipment with monitor
- Local anesthetic with a 1 cc syringe and 30 gauge needle
- Sterile 20 gauge 89 mm (3.5 in.) Access Port needle (supplied with LAP-BAND® System and available as 10 pack: catalog number B-20301-10) or a sterile 20 gauge 51 mm (2 in.) Access Port needle (available as 10 pack: B-20302-10) or a sterile 22 gauge 38 mm (1.5 inch) Access Port needle (available as 10 pack: B-20311-10) or other 20 or 22 gauge non-coring, deflected tip ("Huber tip") needle ONLY. Some non-Allergan "Huber-tipped" needles have been reported to core the Access Port septum. Allergan cannot guarantee that non-Allergan "Huber-tipped" needles are non-coring to the Access Port septum, therefore the use of Allergan Access Port Adjustment Needles is recommended.
- Sterile, non-pyrogenic isotonic saline solution in a 1 cc syringe for normal adjustments or a larger syringe when the total amount of band fluid is being measured.
- A washer or coin for localizing the port.

OPERATOR'S MANUAL

Prophylactic Antibiotics

The perioperative administration of prophylactic antibiotics, which would cover the skin and gut flora is recommended.

Pre-operative Upper GI

All LAP-BAND® System patients should have a pre-operative upper GI.

Access Port Preparation

1. Remove Access Port along with the 22 gauge blunt flushing needle from the sterile container.
2. Attach a 5cc saline-filled syringe to the blunt flushing needle.
3. Hold the Access Port in an upright position with the port on the bottom and the Access Port's outlet barb facing up.
4. Inject sterile saline into the Access Port's outlet barb to irrigate the Access Port. As the Access Port fills with sterile saline, air and excess fluid will be forced out of the Access Port past the blunt flushing needle.
5. The Access Port is now full of saline, mostly free of air, and ready to be attached to the implanted band tubing. Keep the Access Port upright until it is attached to the band fill tubing.

BAND PREPARATION

For the Circulator

1. Give Scrub Tech/RN 15 cc of sterile, nonpyrogenic isotonic 0.9% NaCl saline solution and a 10 cc syringe (w/o needle).
2. Prior to opening the box, confirm the size and type of LAP-BAND® System with the surgeon.
3. Do not open or throw away the sterile Access Port Needle unless it is requested by the surgeon. If the needle is not used, label with patient's name and give to the surgeon for future LAP-BAND® System adjustments.
4. Give anesthesiologist the Calibration Tube (packaged separately).

For the Anesthesiologist

1. The Calibration Tube is an oral suction tube which requires a lubricant and 30 cc syringe for inflation.
2. Surgeon will instruct anesthesiologist to remove patient's N/G tube (if one has been inserted). Insert the Calibration Tube orally until it passes below the gastro-esophageal (GE) junction.
3. Surgeon will ask anesthesiologist to inflate balloon with 25 cc of air (or saline) and to pull back on tube until resistance is met – this determines precisely where the GE junction is located.
4. Once the junction is clearly marked, the surgeon will then instruct anesthesiologist to deflate the Calibration Tube and either retract it into the esophagus or remove it entirely.
5. Discard the Calibration Tube after use only when surgeon has completed surgery. During insertion of the calibration balloon, care must be taken to prevent perforation of the esophagus or stomach.

For The Scrub Tech/RN

1. After the Circulator opens outer LAP-BAND AP® System package, pick up inner sterile container by the tab and put on back table in a secure location.
2. Peel outer wrapping at the yellow indicator on the bottom side of the Tyvek® and remove LAP-BAND AP® System and priming needle.
3. Connect priming needle to the LAP-BAND AP® System tubing end.
4. Fill a 20 cc syringe with at least 15 cc of saline and connect syringe to the priming needle. Flush the band and inflatable shell area several times, each time drawing out air bubbles. A residual amount of saline will stay in the LAP-BAND AP® System.
5. View the inflatable portion of the band for leaks or uneven inflation.
6. Inject about 5 cc saline and disconnect the syringe. The excess saline will be forced out of the band, leaving about 4 cc of saline in the LAP-BAND AP® System Standard and 5 cc in the LAP-BAND AP® System Large.
7. At this point, you have replaced most of the air in the LAP-BAND AP® System with saline.
8. Insert the end plug into the tubing end until the stainless steel tubing connector disappears into the open end of the band fill tube – this will facilitate pulling the tube around the stomach (Figure 4). The tubing can be slippery. Using 4x4 gauze sponges will help grasp the tubing.

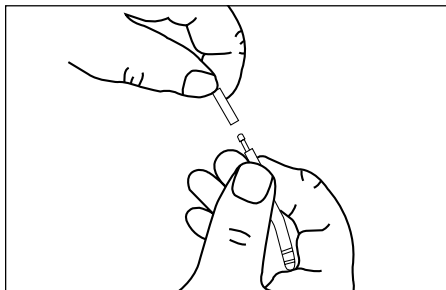

Figure 4. Insertion of Band Tubing End Plug

9. Place the band in saline bowl or set aside until ready for insertion – it is now ready for implantation.
10. If your patient's anatomy requires a larger initial circumference, the LAP-BAND AP® System's perimeter can be made larger by removing saline from the band via the Access Port. It is important to remove any additional saline via the Access Port so no air will enter the LAP-BAND® System, compromising later adjustments.

MAXIMUM FILL CAPACITY VOLUMES		
Cat. No B-2360	Standard	10 cc Max. Volume
Cat. No B-2365	Large	14 cc Max. Volume

PROCEDURE BASICS

As with other surgical decisions, it is the surgeon's responsibility to judge his or her skill and experience as well as the procedure best suited to the patient's needs. Detailed presentations of specific procedures have been published. These publications and additional information regarding procedures are provided in Allergan authorized LAP-BAND® System Programs.

It has been reported that a liquid diet prior to surgery may reduce the patient's liver size, providing a clearer view and easier access to the stomach when placing the LAP-BAND® System.

The following information regarding the surgical procedure, adjustments and band removal is intended to supplement, not replace, information provided in these workshops.

LAP-BAND AP® SYSTEM SURGICAL PROCEDURE

Anesthesia: The anesthesiologist typically avoids mask ventilation prior to intubation in order to prevent aspiration of gastric contents into the respiratory tract. Crash induction of anesthesia (injection of anesthetic drugs followed immediately by intubation under cricoid compression) is common in obesity surgery. A nasogastric tube is typically placed after intubation in order to empty the stomach.

Position of the Patient and the Surgeon: The patient is most commonly placed in a lithotomy position, in a moderate anti-Trendelenburg tilt. The hips and the knees are slightly flexed in order to prevent the patient from slipping down the table. This position helps displace the intra-abdominal viscera and the fatty omentum downward so that the upper part of the stomach may be better visualized. The surgeon stands between the patient's legs, the first assistant on the patient's left side and the second assistant on the patient's right.

Pneumoperitoneum: The laparoscopic procedure is performed under carbon dioxide pneumoperitoneum. Pressure is monitored constantly.

Position of the Trocars: Four, five, or six trocars are initially placed for this procedure. The trocars need to be positioned high on the patient's abdomen, and they must be inserted so that they angle towards the gastric hiatus. This is important for better instrument access in the severely obese abdomen. A trocar is needed for introduction of the atraumatic graspers, usually in the right upper quadrant or below the right costal margin. A 15 or 18 mm port is required for introduction of the gastric band, usually in the left paramedial position or on the left anterior axillary line below the costal margin (Access Port site).

Exposure of the Subcardial Area: A liver retractor is placed to hold the left lobe of the liver anteriorly and to the patient's right to expose the esophageal hiatus, the anterior stomach and lesser omentum.

Measurement of the Pouch: The anesthesiologist passes the calibration tube down into the stomach and inflates its balloon with 25 cc of air (some surgeons prefer saline). The balloon is withdrawn upwards until it is against the gastroesophageal junction (Figure 5).

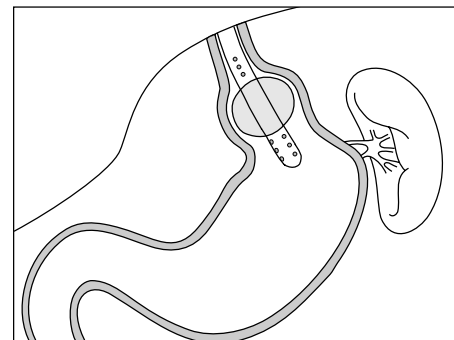

Figure 5. Calibration Tube balloon withdrawn upwards against the gastroesophageal junction

This permits correct selection of the location along the lesser curvature and into the phrenogastric ligament to perform the blunt dissection (Figure 6).

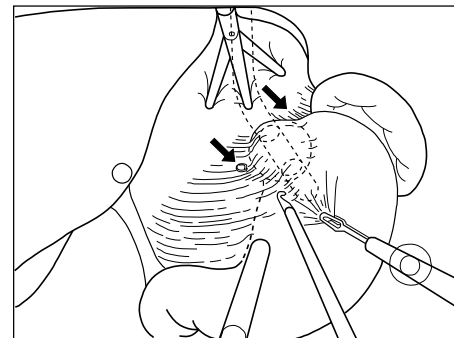

Figure 6. Calibration Tube balloon and dissection point selected

LESSER CURVE DISSECTION OPTIONS

Recommended Technique

PARS FLACCIDA: Dissection begins directly lateral to the equator of the calibration balloon in the avascular space of the Pars Flaccida. After seeing the caudate lobe of the liver, blunt

dissection is continued under direct visualization until the right crus is seen, followed immediately by the left crus over to the angle of His.

The PARS FLACCIDA technique is recommended as it is the most widely used method for laparoscopic adjustable gastric banding and results in a reduced incidence of gastric prolapse and pouch dilation compared to the PERI-GASTRIC technique (described below).

Alternative Techniques

PERI-GASTRIC: Dissection starts directly on the lesser curve at the mid-point (equator) of the calibration balloon. Dissection is completed behind the stomach toward the angle of His under direct visualization, taking care to avoid the lesser sac. Retro-gastric suturing is an option (Figure 7).

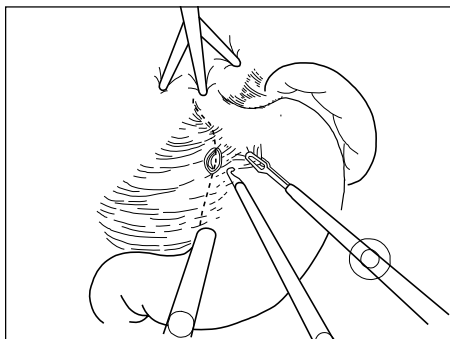

Figure 7. Dissection of the lesser curvature

PARS FLACCIDA TO PERI-GASTRIC: Dissection begins with the Pars Flaccida technique (above). A second dissection is made at the mid-point (equator) of the balloon near the stomach until the peri-gastric dissection intercepts the Pars Flaccida dissection. The band is then placed from the angle of His through to the peri-gastric opening.

Under direct vision, the full thickness of the hepatogastric ligament is dissected from the gastric wall to make a narrow opening. The posterior gastric wall should be clearly recognizable. The dissection should be the same size as the band or even smaller to reduce the possibility of band and/or stomach slippage.

Dissection of the Greater Curvature: A very small opening is created in the avascular phrenogastric ligament, close to the gastric wall at the Angle of His.

Retrogastric Tunnel: Always under direct vision, blunt dissection is continued towards the Angle of His until the passage is completed (Figure 8).

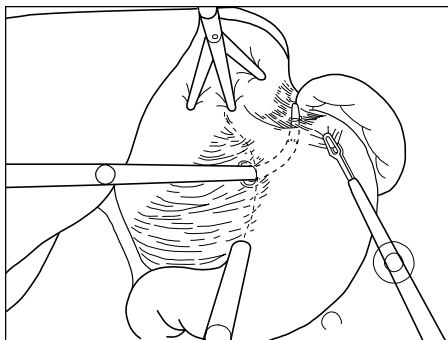

Figure 8. Posterior instrument passage

WARNING: Do not push the tip of any instrument against the stomach wall or use excessive electrocautery. Stomach perforation or damage may result. Stomach perforation may result in peritonitis and death.

WARNING: Any damage to the stomach during the procedure may result in erosion of the device into the GI tract.

CAUTION: Do not over-dissect the opening. Excessive dissection may result in movement or erosion of the band. A blunt instrument is gently passed through the retrogastric tunnel.

Introduction and Placement of the Band: The inflatable band and Access Port are flushed with sterile saline (see "Band Preparation" and "Access Port Preparation"). The band is introduced into the abdomen via a 15 mm or 18 mm trocar. The band is pulled, end plug first, into place around the stomach with the instrument previously placed through the retrogastric tunnel (Figure 9).

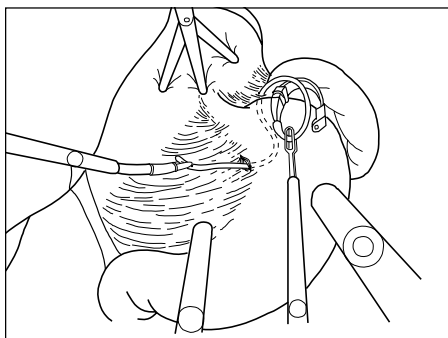

Figure 9. Placement of the band

The tubing is inserted into the band's buckle. The band is locked in place using atraumatic graspers.

CAUTION: Failure to use an appropriate atraumatic instrument to lock the band may result in damage to the band or injury to surrounding tissues.

Opening or Unlocking the LAP-BAND AP® System: The LAP-BAND AP® System provides for the re-opening of the band in the case of slippage or malposition. With atraumatic graspers, stabilize the band by grasping the ridge on the back of the band. With the other grasper, pull the buckle tab up (see Figure 10) and slide the tubing through the buckle until there is ample area to adjust the position of the band.

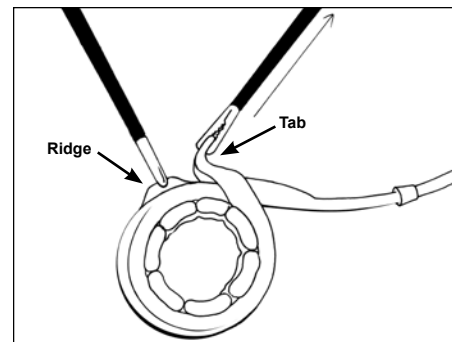

Figure 10. Unlocking the LAP-BAND AP® System

CAUTION: Failure to create a new tunnel for the band during repositioning may lead to further slipping.

Retention Gastro-gastric Sutures: Multiple non-absorbable sutures are placed between the seromuscular layer of the stomach just proximal and distal to the band. Sutures should be placed from below the band to above the band, pulling the stomach up over the band until the smooth surface of the band is almost completely covered. The tubing and buckle area should not be included in the gastro-gastric imbrication (Figure 11).

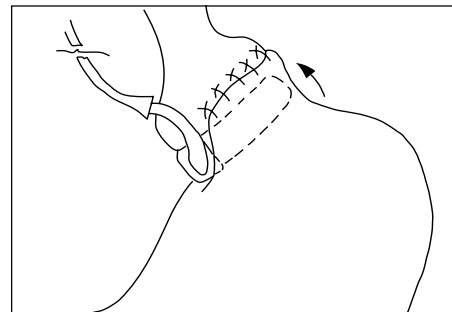

Figure 11. Suturing the greater curvature over the LAP-BAND® System and pouch

Access Port Placement and Closure: The band tubing is brought outside the abdomen and is connected to the Access Port. The port is then placed on the rectus muscle or in an accessible subcutaneous site. The tubing may be shortened to tailor the position of the port to the patient while avoiding tension between the port and the band. The Strain Relief is threaded over the LAP-BAND AP® System tubing with the locking mechanism end of the Strain Relief pointing toward the end of the tubing; allow 2 cm of tubing to extend beyond the Strain Relief (Figure 12).

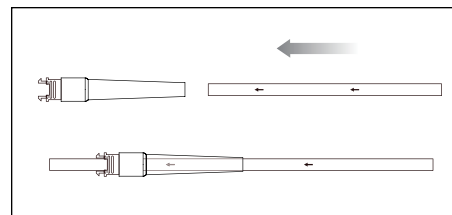

Figure 12. Strain Relief and end of tubing alignment

The tubing is then pushed onto the Access Port's outlet barb until the tubing is flush against the Access Port (Figure 13).

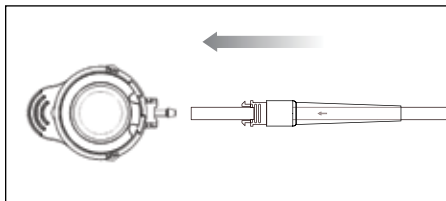

Figure 13. Tubing alignment with Access Port's outlet barb

The Strain Relief is then locked into the Access Port's port housing (Figure 14).

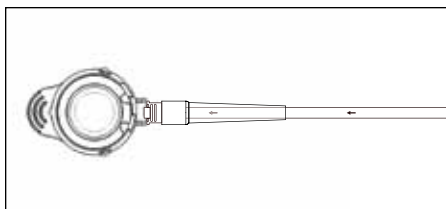

Figure 14. Strain Relief locked into the Access Port's port housing

The RapidPort® EZ Access Port's safety cover (black cover) is then removed and discarded and the access port is placed on, or in the rectus muscle or in an accessible subcutaneous site. The access port is sutured in place utilizing the three suture holes in the port base or secured in place by use of the RapidPort® EZ Port Applier (B-20390) or other fixation method. Refer to the RapidPort® EZ Port Applier Directions for Use for detailed information on the RapidPort® EZ fixation feature.

The trocar holes are closed.

INSTRUCTIONS FOR USE: BAND ADJUSTMENT

The following are general guidelines for LAP-BAND® System adjustments:

1. The initial postoperative adjustment should occur at six weeks or more after placement, when usually 3-4 cc of normal saline would be added.
2. The patient should be reviewed regularly (every 4-6 weeks), depending on patient need, with weight and clinical status measured. If the weight loss has averaged less than 1 lb per week over the period and the patient indicates there is no excessive restriction to eating, a further increment of fluid should be added.
3. Normally, additional fluid would not be added if average weight loss has been greater than 2 lbs per week between visits.
4. If the weight loss averaged between 1 and 2 lbs per week, additional fluid would be indicated if the patient felt he/she could eat too freely or found it difficult to comply with the dietary rules.
5. Fluid would be removed from the system if there were symptoms of excessive restriction or obstruction, including excessive sense of fullness, heartburn, regurgitation and vomiting. If symptoms are not relieved by removal of the fluid, barium meal should be used to evaluate the anatomy.

Prior to doing an adjustment to decrease the stoma, review the patient's chart for total band volume and recent adjustments. If recent adjustments have not been effective in increasing restriction and the patient has been compliant with nutritional guidelines, the patient may have a leaking band system, pouch enlargement or esophageal dilatation due to stomal obstruction, band slippage or over-restriction.

LAP-BAND® System patency can be confirmed by injecting saline into the band system, then immediately withdrawing it. An absence or decrease in fluid volume indicates that a leak in the system may exist. The band may be evaluated for a leak using a radiopaque solution, such as Hypaque or Conray-43, flushing it from the band system after the evaluation. If pouch enlargement or band/stomach slippage is suspected, a limited upper GI with a small amount of barium or gastrografin can be used to evaluate the size of the pouch, the gastric stoma and the position of the band.

CAUTION: Insufficient weight loss may be a symptom of inadequate restriction (band too loose), or pouch or esophageal enlargement, and may be accompanied by other symptoms, such as heartburn, regurgitation or vomiting. If this is the case, inflation of the band would not be appropriate.

Excessive restriction may result in a closed stoma. Because of the possible complications that can occur with excessive restriction, a doctor familiar with the adjustment procedure must be available for several days post-adjustment to adjust the stoma in case of an emergency. (See CAUTION after step 10).

Deflation (an increase in stoma size) is considered if the patient experiences frequent episodes of vomiting, is unable to swallow liquids or appropriate foods, or if there are medical indications for increasing nutrient intake. Elective deflation of the band is advisable in the following situations:

- Pregnancy
- Significant concurrent illness
- General anesthesia
- Remote Travel
- Travel to areas where food or water contamination is endemic

WARNING: Esophageal distension or dilatation has been reported and may be associated with stoma obstruction due to incorrect band placement or over-restriction due to excessive band inflation. Patients should not expect to lose weight as fast as gastric bypass patients, and band inflation should proceed in small increments. Deflation of the band is recommended if esophageal dilatation develops.

If esophageal dilatation is present, then steps should be taken to identify and resolve the cause(s). Deflation of the band may resolve dilatations that are entirely due to over-restriction. Dietary evaluation and appropriate nutritional counseling regarding correct eating behavior should follow band deflation and precede subsequent gradual re-inflations. Re-inflation of the band should be conducted gradually in small increments over several months. Dietary counseling should be ongoing, and repeat upper GI exams should be done at each band adjustment.

Band deflation may not resolve the dilatation if the stoma obstruction is due to a significant gastric slippage or if the band is incorrectly placed around the esophagus. Band repositioning or removal may be necessary if band deflation does not resolve the dilatation.

Adjustment of Port Located Within Rectus Sheath and/or Deep Below Adipose Tissue

Access Port Radiographic Profile: The Access Port's tan plastic housing is not radiopaque. An ideal overhead view (0°) of the access port shows two concentric rings. The Access Port for the LAP-BAND AP® System Standard is identified by a single

radiopaque marker, which signifies a fill range of 0-10 cc (Figure 15). The Access Port for the LAP-BAND AP® System Large is identified by two radiopaque markers which signifies a fill range of 0-14 cc (Figure 16).

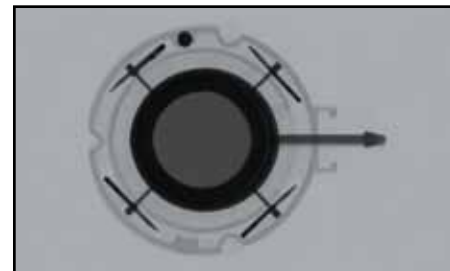

Figure 15. Top or bottom view x-ray image of the LAP-BAND AP® System Standard Access Port

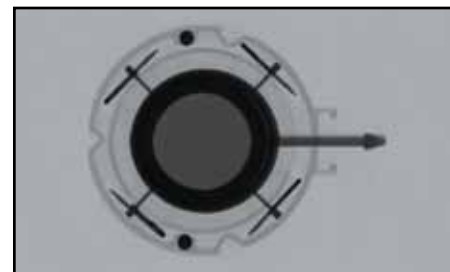

Figure 16. Top or bottom view x-ray image of the LAP-BAND AP® System Large Access Port

Access ports have been reported to be "flipped" or inverted. If you initially see an oblique or side view (Figure 17-18) on x-ray, then either reposition the patient or the x-ray equipment until you obtain a perpendicular, overhead (0°) view. Targeting the port for needle penetration can be difficult if this orientation is not controlled. Be aware that an upside down (180°) port shows the same image.

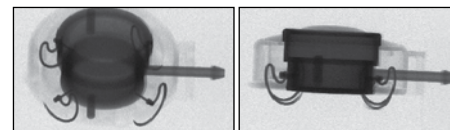

Figure 17. Oblique x-ray (left), Side x-ray (right) view of Access Port

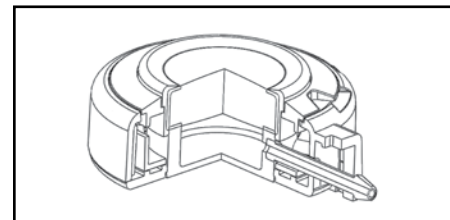

Figure 18. Cross section drawing view of Access Port

Steps for Performing an Adjustment

1. Shield the reproductive organs of all patients if using radiology to locate the Access Port.

- Wash your hands with a germicidal solution. Sterile gloves are advised. Always penetrate the Access Port using aseptic technique.
- Complete a skin prep with an antiseptic solution.
- Locate the Access Port radiologically or by manual palpation.
- Local anesthesia may be used to eliminate pain during injection.
- Position the needle perpendicularly to the septum of the Access Port (Figure 19)

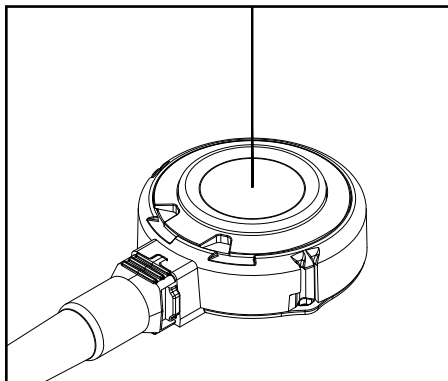

Figure 19. Needle and Access Port positioning

CAUTION: When adjusting band volume, the needle must be inserted perpendicular to the Access Port septum. Failure to do so may cause damage to the port and result in leaks.

CAUTION: Use of an inappropriate needle may cause Access Port leakage and require reoperation to replace the port. Do not use standard hypodermic needles as these may cause leaks. Use only LAP-BAND® System Access Port Needles or other 20 or 22 gauge non-coring (only), deflected tip ("Huber tip") needle. Some non-Allergan "Huber-tipped" needles have been reported to core the Access Port septum. Allergan cannot guarantee that non-Allergan "Huber-tipped" needles are non-coring to the Access Port septum, therefore the use of Allergan Access Port Adjustment Needles is recommended.

CAUTION: Take care to ensure that the radiographic screen is perpendicular to the needle shaft (the needle will appear as a dot on the screen). This will facilitate adjustment of needle position as needed while moving through the tissue to the port.

- When the Access Port is felt, and just prior to penetrating it, you may confirm radiographically that the needle is properly positioned. Attach a syringe to the needle before penetrating the port. A one-way stopcock can be connected to the needle to prevent fluid loss.

CAUTION: Never enter the Access Port with a "syringeless" needle. The fluid in the device is under pressure and will be released through the needle.

- Penetrate the Access Port. The port must be penetrated until the needle is stopped by the bottom of the portal chamber. Withdraw some saline to confirm that the bevel of the needle is within the port. If, after penetration, the saline solution cannot be withdrawn or injected, the bevel of the needle may be occluded by the port septum. Try to advance the needle further into the port to the bottom of the portal chamber. If you cannot advance, then re-enter the port with another sterile needle.

CAUTION: Once the septum is punctured, do not tilt or rock the needle, as this may cause fluid leakage or damage to the septum.

- To increase stoma size: Taking into account any fluid withdrawn to confirm port penetration, remove fluid to deflate the band and increase the stoma size. Take care to remove only enough fluid to deflate the band; avoid creating a vacuum.
- To decrease stoma size: Taking into account any fluid withdrawn to confirm port penetration, inject additional saline to further inflate the band and decrease the stoma size.

CAUTION: Important: If fluid has been added to decrease the stoma size, it is important to establish that the stoma is not too small, before discharge. Check the adjustment by having the patient drink water. If the patient is unable to swallow, remove some fluid from the port, then recheck. A physician familiar with the adjustment procedure must be available for several days post-adjustment to deflate the band in case of an obstruction.

ADJUSTMENT FOLLOWING SIGNIFICANT WEIGHT LOSS

Once significant weight has been lost it may become possible to palpate and locate the Access Port without the use of x-ray. If this is the case, complete all the other steps, skin prep, aseptic technique, etc. An evaluation of the stoma and pouch size is recommended via a gastrografin or limited barium swallow prior to and following adjustments. This is important to avoid inadvertent overinflation of the band and possible stoma obstruction.

BAND REMOVAL/REPOSITIONING

The band can be unlocked, removed and/or repositioned if necessary. The band is usually surrounded by a thin, clear capsule. After entering the abdomen via laparotomy or a laparoscopic approach, cut open the capsule and unlock the band as described previously, reposition the band, and complete the band placement as previously described.

NO LATEX

The LAP-BAND AP® Adjustable Gastric Banding System contains no latex or natural rubber materials.

MEDICAL IMAGING

The LAP-BAND® System has been proven to be MRI safe per testing conducted by Allergan when exposed to 3T or lower MRI scans. (Please refer to MRI-Safety.com for more information).

RETURNED GOODS POLICY

Authorization must be received from your Allergan Account Manager prior to return of the merchandise. Merchandise returned must have all the manufacturer's seals intact to be eligible for credit or replacement. Returned products are subject to restocking charges.

No credit will be issued on marked or damaged boxes with stickers.

SPECIAL NOTICE

The manufacturer of the LAP-BAND AP® Adjustable Gastric Banding System has designed, tested and manufactured it to be reasonably fit for its intended use. However, the LAP-BAND AP® System is not a lifetime product and it may break or fail, in whole or in part, at any time after implantation and notwithstanding the absence of any defect. Causes of partial or complete failure include, without limitation, expected or unexpected bodily reactions to the presence and position of the implanted device, rare or atypical medical complications, component failure and normal wear and tear. In addition, the LAP-BAND AP® System may be easily damaged by improper handling or use. Please refer to the adverse events section in this document and to the Information for Patients booklet for

a presentation of the warnings, precautions, and the possible adverse events associated with the use of the LAP-BAND AP® Adjustable Gastric Banding System.

REPORTING AND RETURN OF EXPLANTED DEVICES

The reason for explantation should be reported and the explanted device returned to Allergan. In the event of such an explantation, please contact Product Support at 800.624.4261 for an explant kit and explant return instructions.

AUTHORIZED TRAINING PROGRAM AND PRODUCT ORDERING INFORMATION







LAP-BAND® System Placement is an advanced laparoscopic procedure. Surgeons planning LAP-BAND® System placement must participate in a LAP-BAND® System training program authorized by Allergan or an authorized Allergan distributor. This required training program is specific to the Allergan LAP-BAND® System and does not qualify for use with other gastric bands.

For additional information please contact:

Manufacturer
Allergan
Santa Barbara, CA 93111, USA
Tel: (805) 683-6761
Fax: (714) 796-9308

CAUTION: This device restricted to sale by or on the order of a physician.

US Patents: 5,601,604; 5,658,298; 7,762,998; 7,811,275.

	Sterile, Dry Heat Sterilized, Date of Sterilization, Year & Month
	Attention! See instructions for use.
	Single Use Only. Do Not Reuse.
	Use By Year & Month
	Manufacturer
	Date of Manufacture, Year & Month
<p>SN</p>	Serial Number
<p>REF</p>	Catalog Number
	Contains no latex
<p>Rx Only</p>	This device restricted to sale by or on the order of a physician.



Manufacturer
Allergan
Santa Barbara, CA 93111, USA
Tel: (805) 683-6761
Fax: (714) 796-9308

www.lapbandcentral.com
www.allergan.com

L3476 Rev.04 [3476-01] 11/2011

ALLERGAN and the Allergan Corporate Signature logo are trademarks of Allergan, Inc.
® marks owned by Allergan, Inc. All rights reserved. © 2011 Allergan, Inc., Irvine, CA